

API DCC

2010/01/07 15:16:55

RELEASE

SPEC-DC8029-4H1G_01

95023 Ken Chang



Engineering Specification

Model No : DC8029-4H1G

Customer: 404科技

Part No: SPEC-DC8029-4H1G

Revision: 1

Engineer: Ken Chang



AcBel Product Specification

Acbel Part No.	DC8029-4H1G
Model Name	SV24-12-150-1
Description	DC-DC Converter 24Vdc Input, 12Vdc Output, 150W Output Power, Negative ON/OFF control
Revision	Rev 1
Date Issued	12/11/2009

High Output Power, High Efficiency Half Brick, DC8029-4H1G SV24-12-150-1 Module: 18Vdc to 36Vdc Input, 12Vdc Output, Output Power Up to 150W.

World's Most Advanced High Power Density DC-DC Converters.



DESCRIPTION:

The SUPERVERTER™ module is a high density DC-DC converter designed for use in distributed power architectures, workstation, EDP equipment, and telecommunication applications. The surface-mount construction uses a metal baseplate and planar transformer to produce up to 150W in a half brick package. The SUPERVERTER™ module is a suitable replacement for all industry.

OPTIONS

- Remote On/Off Logic Configuration
- Heat Sink Available for Extended Operation

FEATURES:

- Industry Standard Half Brick: 61.0mm x 57.9mm x 12.7mm (2.40in. x 2.28in. x 0.50in.) (Typical)
- High Power Density: Up to 55W/in.³
- High Efficiency: 91% Typical,
- Low Output Noise
- Metal Baseplate
- Thermal Protection
- Input Under Voltage Protection
- Output Over Voltage Protection
- Current Limit Protection: Step down mode
- Short Circuit Protection
- Adjustable Output Voltage: 60% to 110% of .Vo,set (See Fig.6)
- Remote Sense
- Remote On/Off Control: Negative Logic
- RoHS Compliant



SPEC-DC8

SPECIFICATIONS:

ABSOLUTE MAXIMUM RATINGS

950201 張華鈞 Ken

PARAMETER	MIN	TYP	MAX	UNITS	CONDITIONS
Input Voltage (+In to -In)	-0.3		50	V	<100ms
	-0.3		36	V	Continuous
Logic ON/OFF Voltage (ON/OFF to -In)	-0.3		15	V	
Storage Temperature	-40		125	°C	
Storage Humidity	10		95	%	
Operating Temperature	-40		100	°C	Temperature measure shall be taken from the baseplate (Tb).
Operating Humidity	30		95	%	

INPUT SPECIFICATIONS:

PARAMETER	MIN	TYP	MAX	UNITS	CONDITIONS
Operation Input Voltage (Vi)	18	24	36	V	
Maximum Input Current (Ii,max)			10	A	Vi=18V, Io =Io,max
Inrush Transient			2	A^2s	
Input Reflected-Ripple Current: Peak-Peak		40	60	mAp-p	5HZ to 20MHZ, Vin=24V, Io= Io,max, 12uH source Impedance, Cin=690uF, Tb=25°C
Input Ripple Rejection		60		dB	120Hz
Input Under Voltage Protection: Turn-on Threshold		17.5	18	V	Vo=12V, Io =Io,max.
Turn-off Threshold	15.5	16		V	
Hysteresis	1	1.5		V	

OUTPUT SPECIFICATIONS:

PARAMETER	MIN	TYP	MAX	UNITS	CONDITIONS
Output Set Point (Vo,set)	11.95	12	12.05	V	Initial Adjusted Tb=25°C, Vi=24V, Io=Io,max
Output Voltage Tolerance Band			3	%	All Operating Condition
Line Regulation			0.2	%	Vi=20V to 36V
Load Regulation			0.2	%	Io= Io,min to Io,max.
Temperature Drift			0.02	%/ °C	Tb= -40 to 100°C
Output Ripple and Noise Voltage Peak to Peak			250	mVp-p	Bandwidth 5Hz to 20MHz and with 0.1uF MLCC. Output Capacitor: 880uF, Tb=25°C
Output Current (Io,max)	0		12.5	A	At Vo<=12V, if Vo>12V, Output Power (Po) should be less than its rating power.
Output Current Limit	105		165	%Io,max	Current limit inception point Vo=90% of Vo,set,
Output Short Circuit Current			20	Arms	Hiccup Mode
Output Over Voltage Protection	112		140	%Vo,set	Io=0.5A
External Capacitance		880	3000	uF	
Output Power			150	W	



OUTPUT SPECIFICATIONS (CONTINUED):

PARAMETER	MIN	TYP	MAX	UNITS	CONDITIONS
Efficiency		91		%	Vi=24V, Vo=12V, Io=80% of Io,max Tb=25 °C.
Dynamic Response: Peak Deviation Settling Time		3	500	%Vo,set us	Vi=24V, Tb=25°C 25% - 50% -75% load, Δ Io/Δ t=0.1A/us; with Output Capacitor 880uF, Duration outside of Vo,set +/- 1.0% error band

CONTROL SPECIFICATIONS:

PARAMETER	MIN	TYP	MAX	UNITS	CONDITIONS
Logic ON/OFF Remote: Positive: Off-State Voltage On-State Voltage	2.0		0.8	V V	
Negative: Off-State Voltage On-State Voltage	2.0		0.8	V V	
Turn-On Time		50		ms	Vo=90% of Vo,set
Output Voltage Trim Range	60		110	%	Refer to Trim Circuit and Fig. 6
Over Temperature Protection Shutdown Recovery	100	105 90	110	°C °C	Refer to Fig.3 for loca- tion definition Auto. Recovery

ISOLATION SPECIFICATIONS:

PARAMETER	MIN	TYP	MAX	UNITS	CONDITIONS
Input to Output		1500		Vdc	60 seconds
Input to Case		1500		Vdc	60 seconds
Output to Case		500		Vdc	60 seconds
Input to Output Capacitance		2000		pF	
Isolation Resistance	100			Mohm	At Tb=25°C, 70%RH, Output to Baseplate 500VDC

STRUCTURAL DYNAMICS:

PARAMETER	CONDITIONS
Vibration	Sine Wave, 10-55Hz (Sweep for 1 min.), Amplitude 0.825mm Constant (Maximum 5g) X,Y,Z 1 Hour each, At No Operating,
Shock	20g, 166 in/sec, Square Wave

GENERAL SPECIFICATIONS:

PARAMETER	MIN	TYP	MAX	UNITS	CONDITIONS
MTBF		2.3		Mhrs	Tb=40°C, Io=80% of Io,max
Weight		72		g	
Size (WxHxD)		2.40x2.28x0.5		in.^3	

TRIM CIRCUIT:

SPEC-DC8029-4HTG 01
 950201 張華錡 Ken Chang

A. Trim down: The resistor for output voltage trim-down function could be calculated with the following formula:

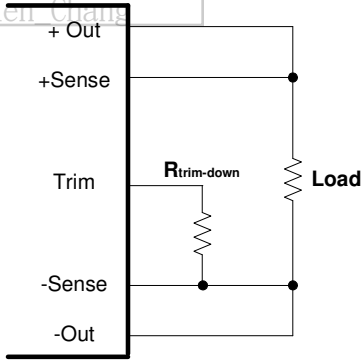

$$R_{trim-down} = \left(\frac{100\% - \Delta\%}{\Delta\%} - 2 \right) (k\Omega)$$

$\Delta\%$: Output voltage change rate against nominal output voltage.

Fig. 1 The schematic for output voltage trim down.

B. Trim up: The resistor for output voltage trim-up function could be calculated with the following formula

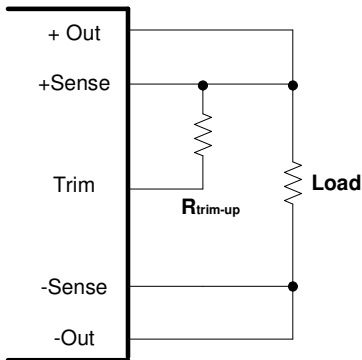

$$R_{trim-up} = \left[\frac{V_o(100\% + \Delta\%)}{1.225\Delta\%} - \frac{(100\% + 2\Delta\%)}{\Delta\%} \right]$$

V_o : The nominal output voltage..

$\Delta\%$: Output voltage change rate against nominal output voltage.

Fig. 2 The schematic for output voltage trim up.

BASEPLATE MEASURE POINT:

UNIT: mm

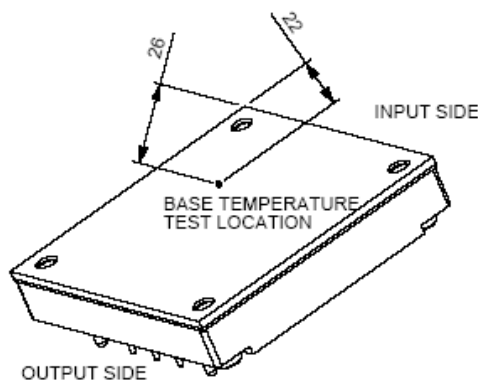

Fig. 3 Baseplate Temperature Measure Point.

EFFICIENCY CURVE :

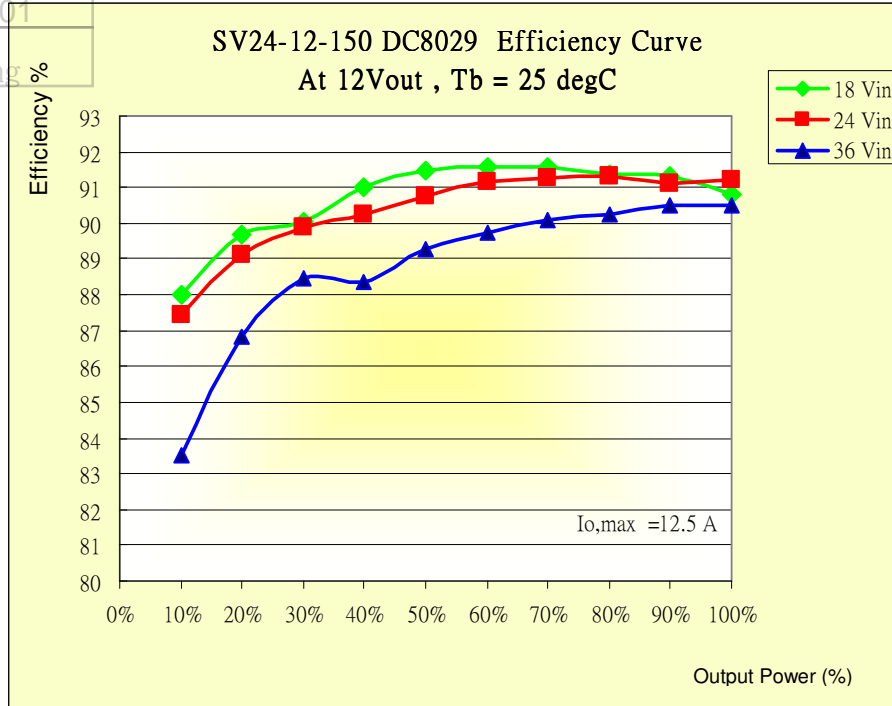

Fig. 4 Efficiency Curve

DERATING CURVE :

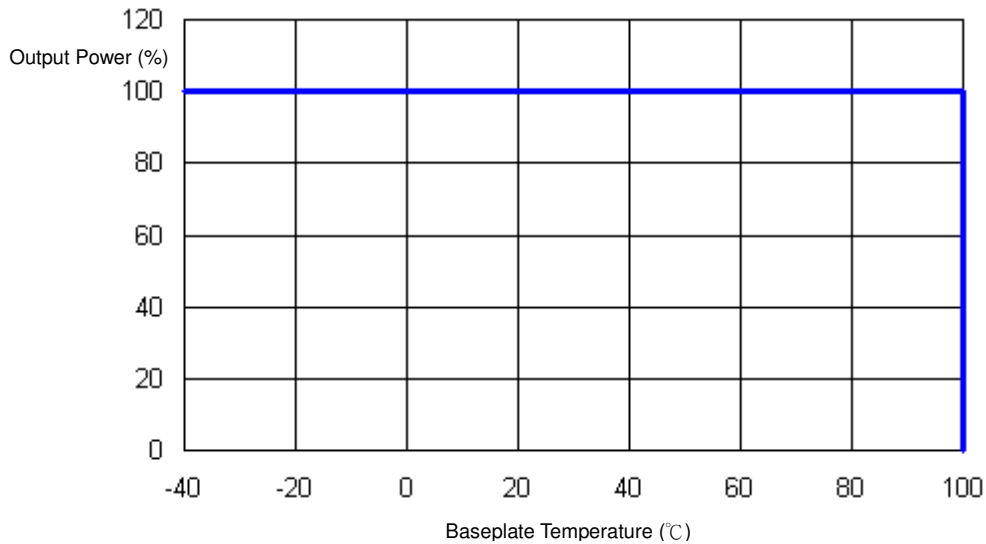

Fig. 5 Derating Curve

OUTPUT VOLTAGE ADJUSTMENT RANGE

SPEC-DC8029-4H1G 01

950201張華錡Ken Chang

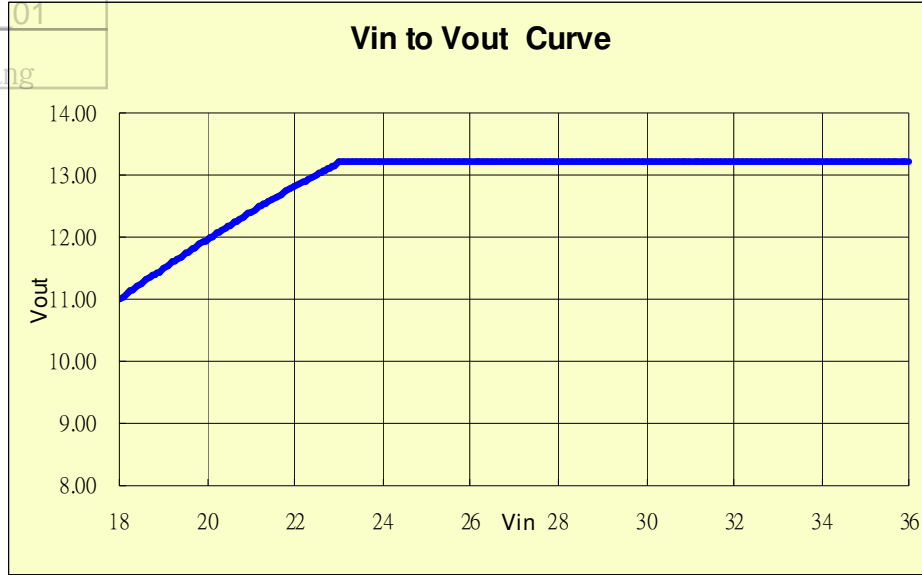

Fig.6 Vin -Vout Curve

OUTLINE DRAWING :

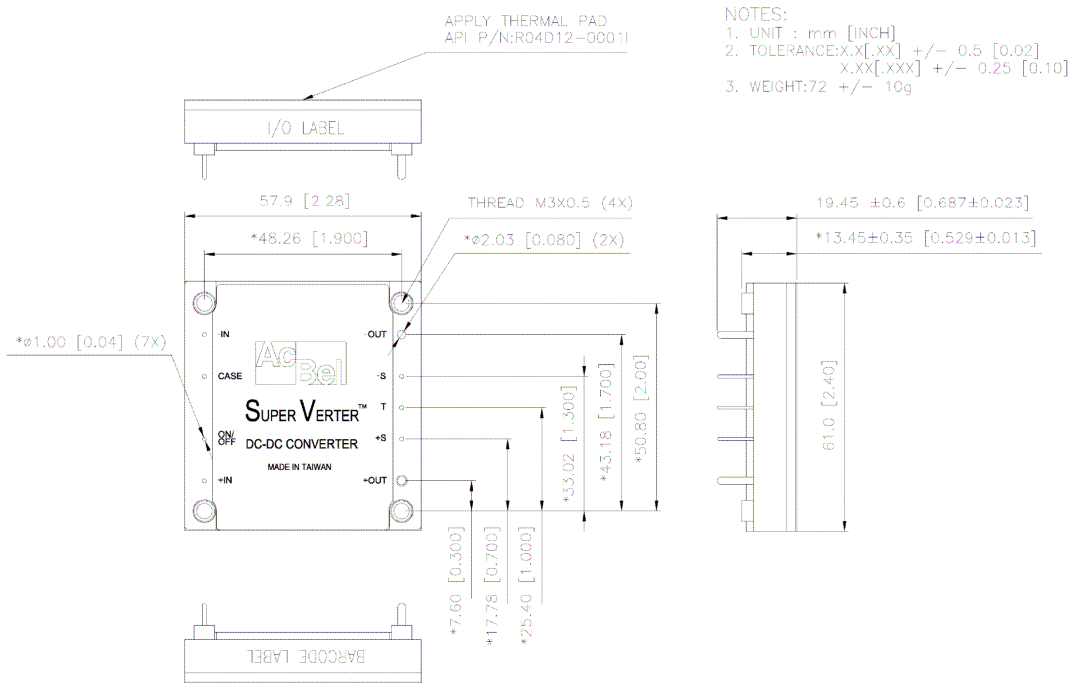

Fig. 7 Outline Drawing